

B-B Corte Vertical

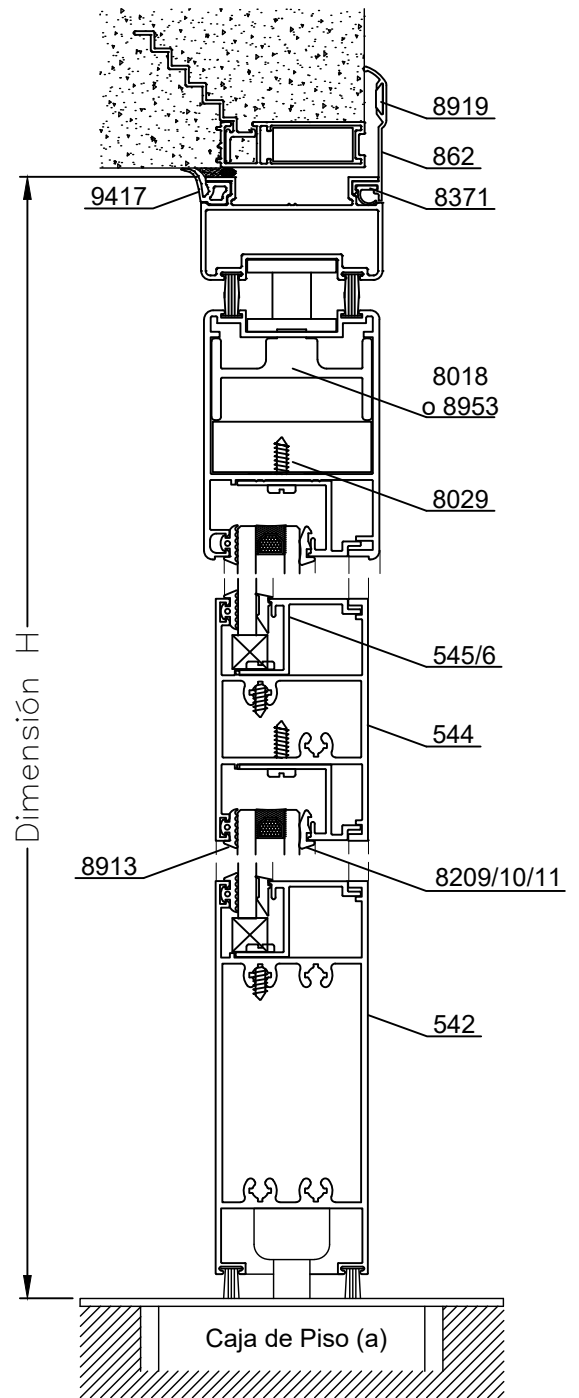

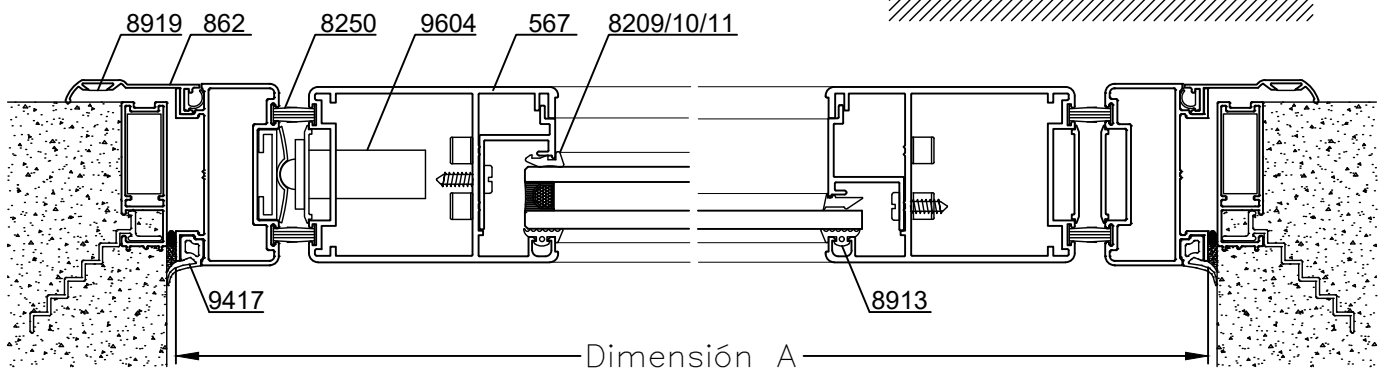



A-A Corte Horizontal



Escala 1:2.5

Tolerancia en Peso +/- 10% Tolerancia largo +10 mm -0 mm











17-12-20 MEDITERRANEA.64

Dimensiones de Corte						
Código	Peso Kg/m	Forma	Función	Cant.	Largo	Corte
597	0,89		Marco	1	A	45° 45°
				2	H	45° 90°
567	1,77		Hoja	1	A-88	45° 45°
				2	H-52	45° 90°
542	2,55		Zócalo	1	A-200	90° 90°
544	1,71		Travesaño	1	A-200	90° 90°
565	0,13		Tapa	2	H-52	90° 90°
566	0,21		Guía Cierre	1	H-52	90° 90°
545/546	-	-	Contra - Vidrio	2	A-200	45° 45°
611/612				2	H-213	45° 45°

Dimensiones de Corte Contramarco: pág. 26

* Medidas en milímetros

Dimensiones de Corte Premarco: pág. 27

Detalle de Accesorios				
Ítem	Código	Descripción	Forma	Cantidad
Esc. de Armado	8017	Escuadra de Armado Mediterránea E-21		2 Unidades
	8018	Escuadra de Armado Pesada E-20		2 Unidades
	8953	Escuadra de Expansión E-20e		
	8029	Escuadra Suplementaria de 52 mm		2 Unidades
Cerradura	9604	Cerradura de Puerta VaiVen	-	1 Unidad
Caja de Piso (a)	----	Caja de Piso Servicio Pesado	-	1 Unidad
	----	Caja de Piso Comun		
Burlete Vidrio	8913	Burlete de Acristalamiento B-68		2A + 2H
Burlete Exterior	9417	Burlete Exterior Cubre Sello		1A + 2H
Cuña Vidrio	8209	Cuña Chica		2A + 2H
	8210	Cuña Mediana		
	8211	Cuña Grande		
Felpa	8250	Felpa de 7x9		6A + 8H
Tornillos	8483	Tornillos Allen de RW $\frac{1}{4}$ " x $\frac{3}{4}$ " mm		8 Unidades
Tapa Tornillos	8431	Tapa de Tornillo T-100		8 Unidades
Tornillo	-	Tornillo de Fijación Perfil Contravidrio		s/m

s/m: según medida

Accesorios Contramarco: pág. 26

Accesorios Premarco: pág. 27

 (a) Caja de Piso: Producto no comercializado por Alcemar